

Anglo-Chinese School (Junior)



SEMESTRAL ASSESSMENT (2021)

PRIMARY 5

SCIENCE

BOOKLET A

Monday

1 November 2021

1 hr 45 min

Name: _____ () Class: 5.()

INSTRUCTIONS TO PUPILS

- 1 Do not turn over the pages until you are told to do so.
- 2 Follow all instructions carefully.
- 3 There are 28 questions in this booklet.
- 4 Answer ALL questions.
- 5 Shade your answers in the Optical Answer Sheet (OAS) provided.

This question paper consists of 20 printed pages (inclusive of cover page).

For each question from 1 to 28, four options are given. One of them is the correct answer. Make your choice (1, 2, 3 or 4). Shade your answer on the Optical Answer Sheet.

(56 marks)

1. Which is the main reason why bread mould is not considered a plant?

- (1) It reproduces by spores.
- (2) It does not have flowers.
- (3) It is not found in the garden.
- (4) It does not have chlorophyll.

2. Study the flowchart.

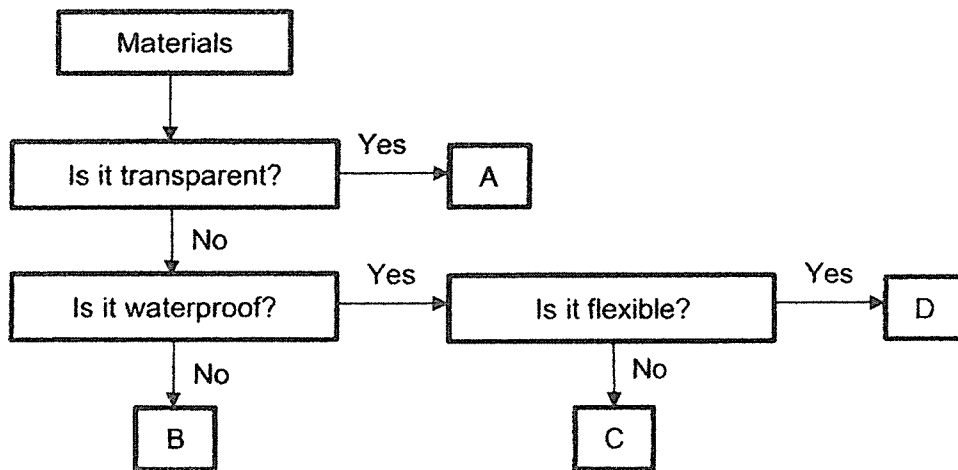

Tom used a cover to protect his car.

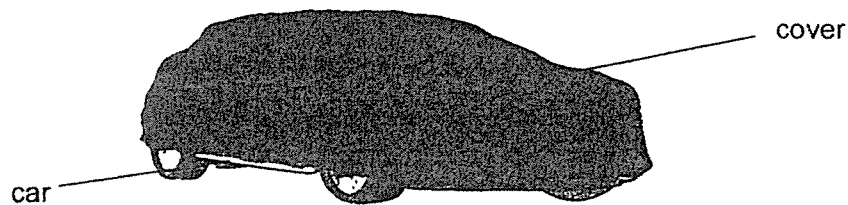

Which material, A, B, C or D, is best used to make the cover?

- (1) A
- (2) B
- (3) C
- (4) D

3. Linus set up the following experiment to find out if strips X, Y and Z are made of magnetic material. He placed each strip between two similar magnets. The results are as shown.

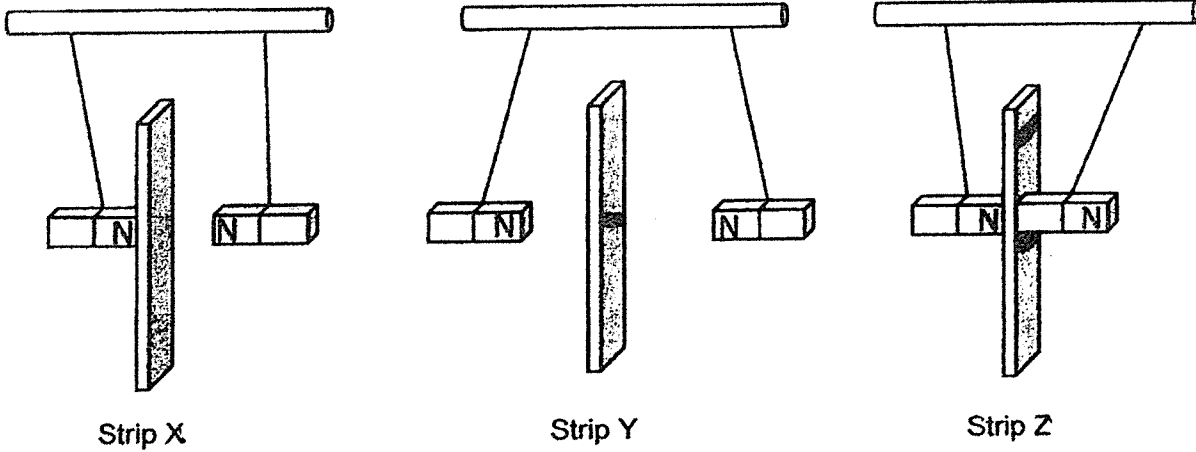

Which strip(s) is/are definitely made of non-magnetic material?

- (1) Y only
 - (2) Z only
 - (3) X and Z only
 - (4) X and Y only
4. Which method(s) is/are **not** used to increase the strength of an electromagnet?
- A Adding more batteries to the circuit.
 - B Heating the iron rod of the electromagnet over a flame.
 - C Wrapping more coils of wire around the iron rod in the electromagnet.
- (1) A only
 - (2) B only
 - (3) A and C only
 - (4) B and C only

5. Marcus set up an experiment as shown. As he slid a strong bar magnet from left to right at the same distance from the plate, he recorded if the magnet interacted with the iron ball. He repeated the experiment with similar sized plates made of different materials.

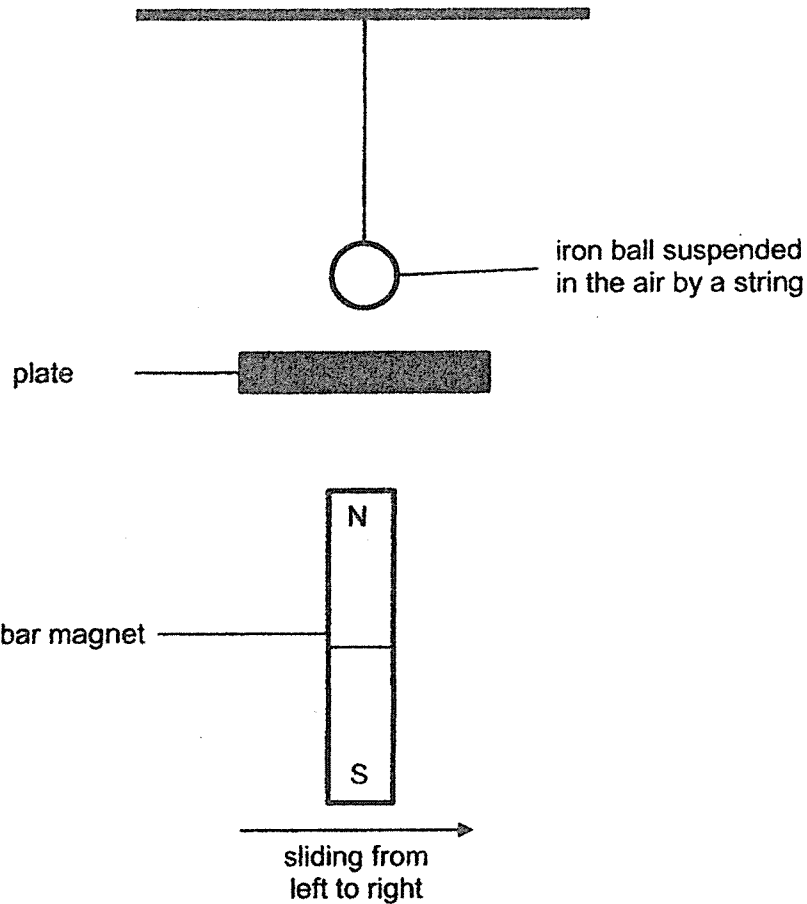

Which observations made by Marcus are true?

	Plate	Interaction between magnet and iron ball
A	Glass	No
B	Copper	Yes
C	Steel	No
D	Cardboard	Yes

- (1) A and C only
 (2) A and D only
 (3) B and C only
 (4) B, C and D only

6. A group of students planted the same number of identical seeds into equal amounts of soil and placed them in rooms at different temperatures. They recorded the number of seeds that germinated at the end of each day in the table.

Temperature (°C)	Total number of seeds that germinated				
	Day 1	Day 2	Day 3	Day 4	Day 5
5	0	0	0	0	1
15	0	0	3	5	7
30	0	2	6	14	18

Which conclusion is correct?

- (1) No seeds germinated at 5°C.
 - (2) All the seeds germinated at 15°C.
 - (3) The seeds germinated the fastest at 30°C.
 - (4) The best temperature for seeds to germinate is 15°C.
7. Which function of the human body system is **incorrect**?

	Human body system	Function
(1)	Circulatory system	Transports oxygen in the blood to all parts of the body
(2)	Digestive system	Breaks down food into simple substances
(3)	Muscular system	Supports the body
(4)	Skeletal system	Gives the body its shape

8. Which of the following is/are animal cells?

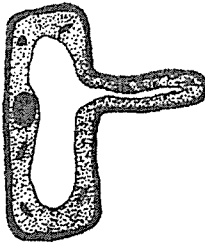

Cell A

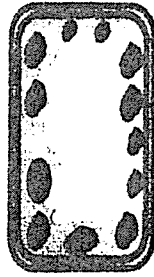

Cell B



Cell C

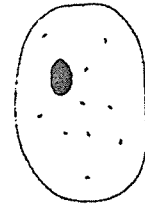

Cell D

- (1) D only
- (2) A and B only
- (3) C and D only
- (4) A, B and C only

9. Patrick mixed some red-coloured water and yellow-coloured water in a beaker. He observed that the colour of the water turned orange after mixing.

He then cut the stalk of a white rose and placed each cut stalk into two separate beakers, one with red-coloured water and the other in yellow-coloured water.

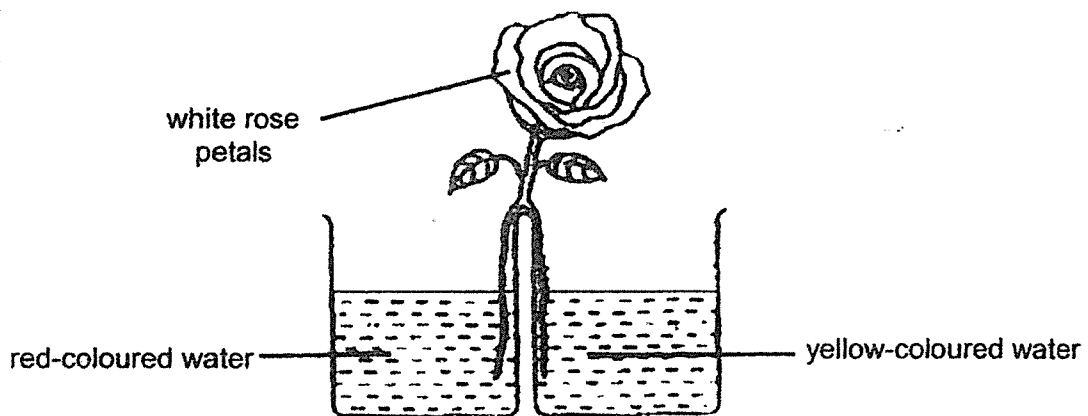

What would the colour of the white rose petals change to after a day?

- (1) orange only
- (2) red and yellow only
- (3) orange and red only
- (4) orange and yellow only

10. Which two statements are true?

- A Both plants and animals respire to give out oxygen.
- B Both plants and animals respire and photosynthesise.
- C Only plants take in carbon dioxide and give out oxygen.
- D Both plants and animals take in oxygen and give out carbon dioxide when they respire.

- (1) A and B
- (2) A and D
- (3) B and C
- (4) C and D

11. Bala carried out three different activities, P, Q and R for 30 minutes. He measured his heart rate and breathing rate immediately after completing each activity. He recorded the readings in the table as shown.

Activity	Heart rate (per min)	Breathing rate (per min)
P	75	35
Q	135	65
R	110	50

What activities can P, Q and R likely be?

	P	Q	R
(1)	Running	Resting	Walking
(2)	Resting	Walking	Running
(3)	Resting	Running	Walking
(4)	Walking	Running	Resting

12. Denzel constructed a circuit by connecting an identical battery, three identical bulbs and two identical switches in working condition. He closed one of the two switches and found that all three bulbs lit up.

Which two of the following are possible circuits constructed by Denzel?

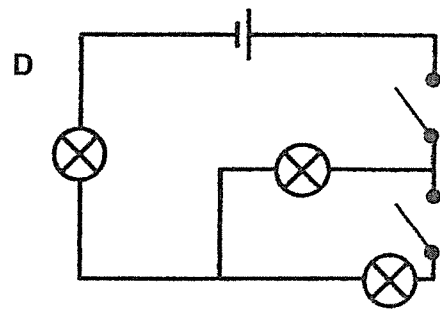
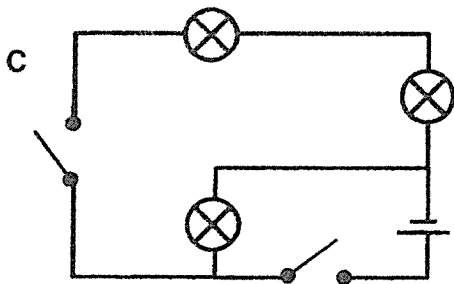
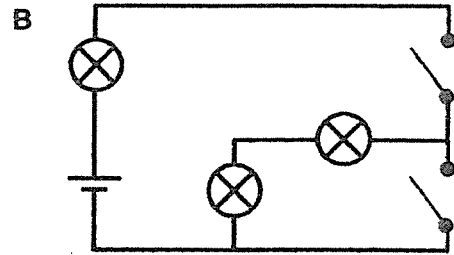
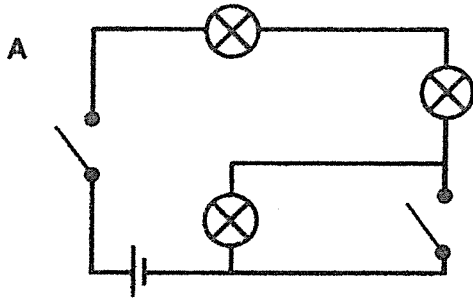

- (1) A and B
 (2) A and C
 (3) B and D
 (4) C and D

13. Study the circuit diagram with bulbs and batteries in working condition.

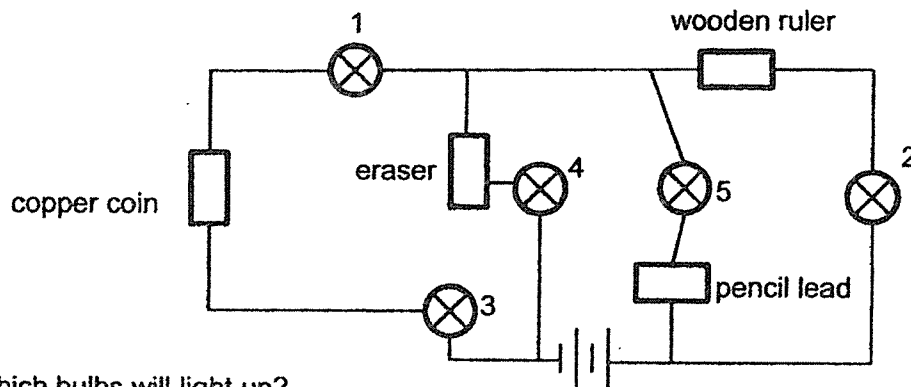

Which bulbs will light up?

- (1) 1, 3 and 4 only
 (2) 1, 3 and 5 only
 (3) 2, 4 and 5 only
 (4) 3, 4 and 5 only

14. Thaddeus bought a buzz wire game as shown. He must move the metal ring from one end of the board at P to the other end at Q, without touching the metal structure. If the metal ring touches the metal structure, the buzzer will sound.

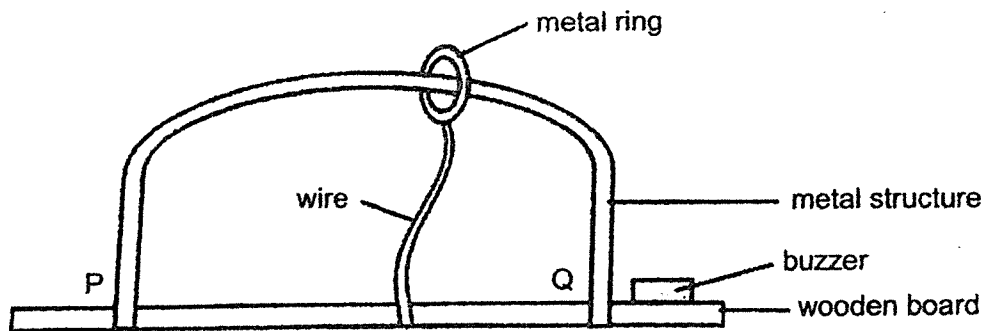

Why will the buzzer sound continuously while the metal ring is touching the metal structure?

- (1) The metal ring provides the energy needed for the buzzer to sound.
 - (2) The buzzer fuses when the metal ring comes into contact with the metal structure.
 - (3) The wooden board forms a closed circuit with the wire and metal structure.
 - (4) The metal ring closes the circuit when it comes into contact with the metal structure.
15. Alex placed a block of ice on a table in his classroom. After a while, Alex observed some water forming around the block of ice as shown.

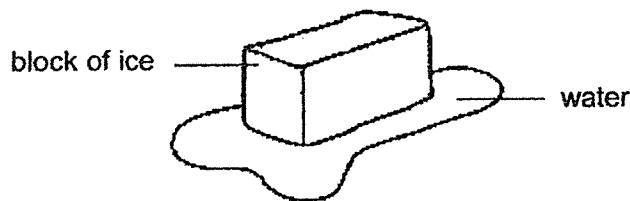

Which of the following is/are correct?







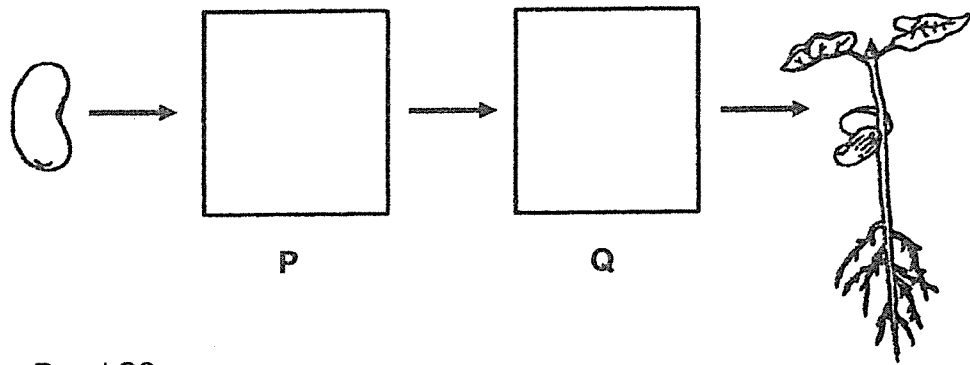

- W The water gained heat from the ice.
- X The ice gained heat from the surrounding air.
- Y The surrounding air gained heat from the water.
- Z The temperature of the ice increased during melting.

- (1) X only
- (2) Z only
- (3) X and Y only
- (4) W and Z only

16. The diagram shows the growth of a seed to a young plant.



What are P and Q?

	P	Q
(1)		
(2)		
(3)		
(4)		

17. Sam made the following observations about the life cycle of an animal.

- There are four stages in its life cycle.
- The young lives in water but the adult lives on land.

Which animal was Sam observing?

- (1) frog
- (2) butterfly
- (3) mosquito
- (4) cockroach

18. Dan had two similar boxes, P and Q, each with a capacity of 500 cm^3 . He placed a 100 cm^3 plasticine ball inside box P. Both boxes were then sealed with an air-tight cover as shown. An additional 200 cm^3 of air was pumped into both boxes P and Q using a pump.

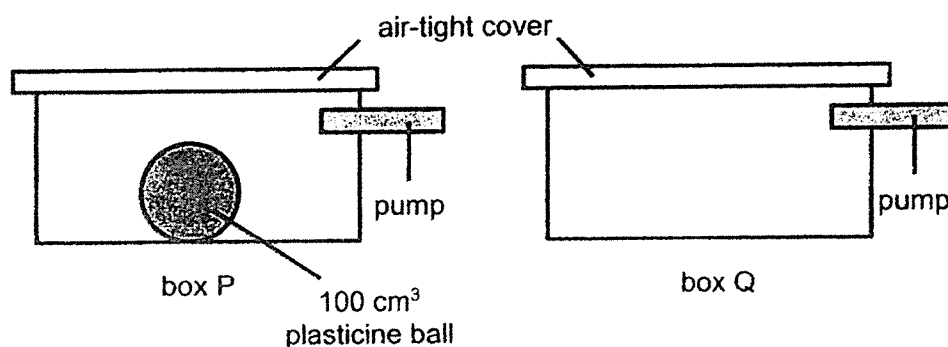

What is the final volume of air in each box?

	Box P	Box Q
(1)	400 cm^3	500 cm^3
(2)	400 cm^3	700 cm^3
(3)	500 cm^3	500 cm^3
(4)	600 cm^3	700 cm^3

19. Mandy classified three fruits using a flowchart.

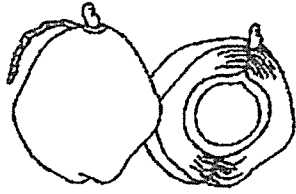

Fruit P



Fruit Q

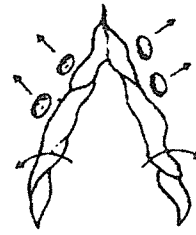

Fruit R

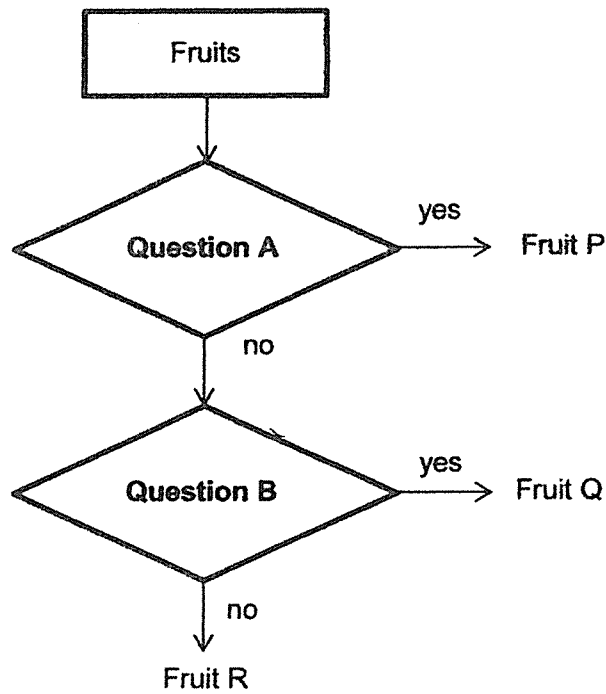

What are questions A and B?

	Question A	Question B
(1)	Does it have a pod?	Is it dispersed by wind?
(2)	Does it have a fibrous husk?	Is it dispersed by explosive action?
(3)	Does it have a pod?	Is it dispersed by explosive action?
(4)	Does it have a fibrous husk?	Is it dispersed by wind?

20. The diagram shows the cross-section of two flowers X and Y from different plants.

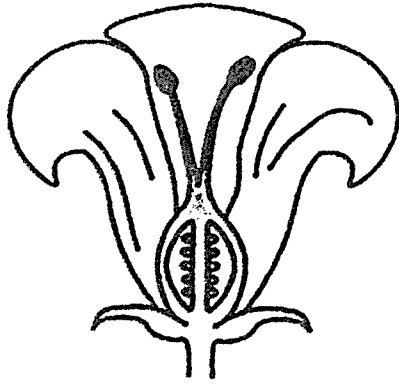

Flower X

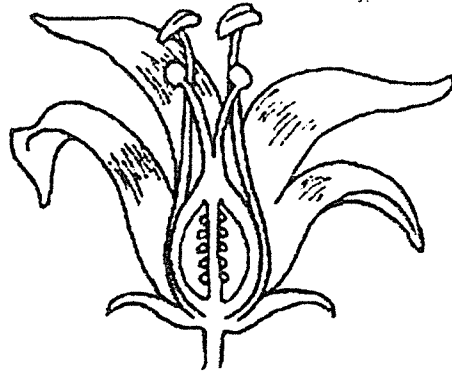

Flower Y

Which of the following about flowers X and Y are correct?

	Flower X	Flower Y
(1)	It can develop into a fruit.	It has both male and female reproductive cells.
(2)	It cannot develop into a fruit.	It does not need to be pollinated to develop into a fruit.
(3)	It has male reproductive cells.	It does not need to be pollinated to develop into a fruit.
(4)	It cannot be pollinated.	It has both male and female reproductive cells.

21 The diagram shows a flowering plant.

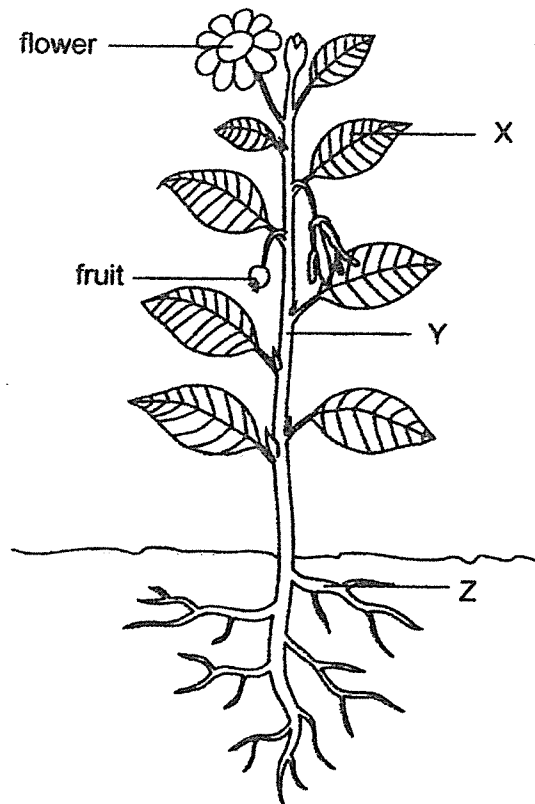

What are the functions of the parts labelled X, Y and Z?

	X	Y	Z
(1)	To make food for the plant	To take in sunlight for the plant	To transport food to the leaf
(2)	To grow into a new plant	To grow into a fruit	To absorb sunlight for the plant
(3)	To make food for the plant	To hold the plant upright	To absorb water for the plant
(4)	To absorb water for the plant	To store seeds for the plant	To grow into a flower

22. Three identical containers, P, Q and R, are filled with equal volumes of water at different temperatures and covered with identical lids. They are placed in the same room.

Water droplets formed on containers Q and R as shown.

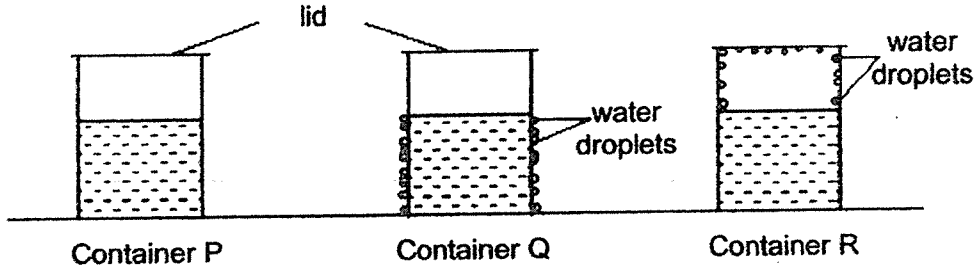

Which graph shows the correct temperature of water in each container at the start of the experiment?

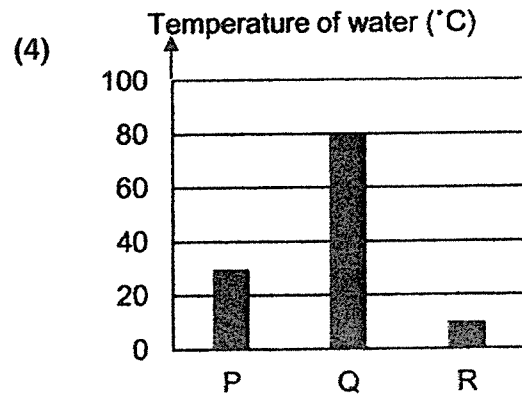
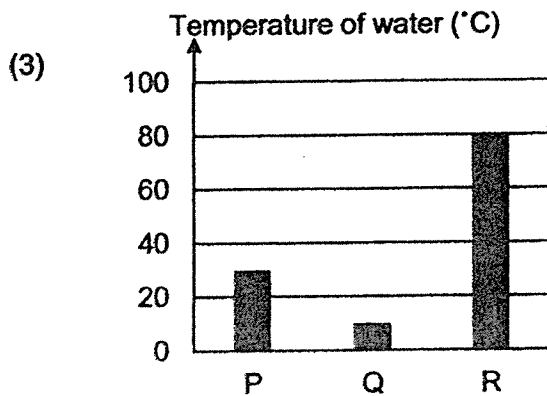
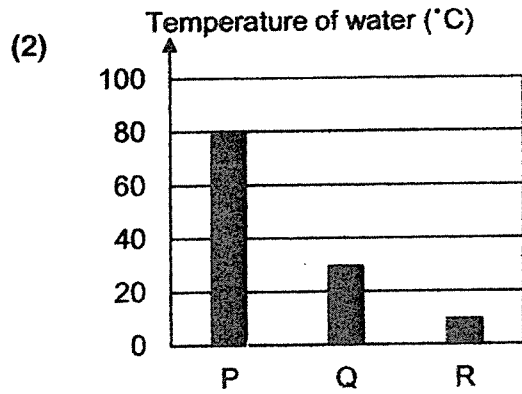
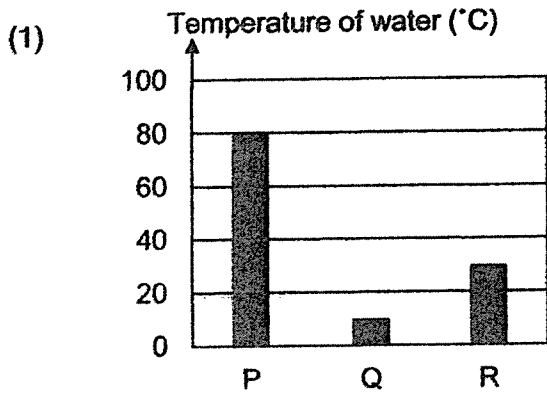

23. The diagram shows the changes in state of a substance.

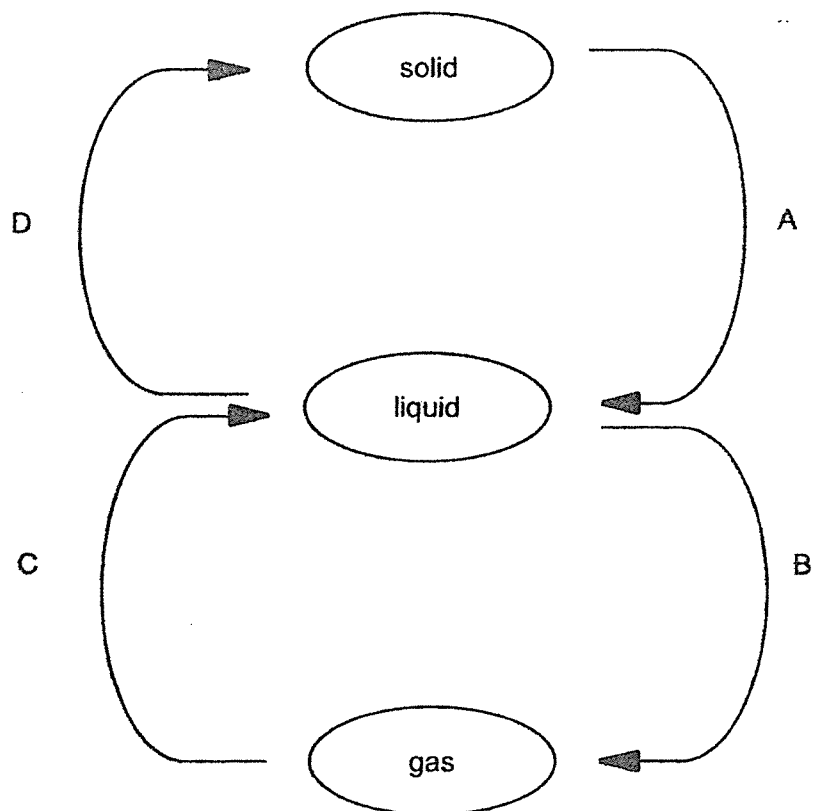

What are processes B, C and D?

	B	C	D
(1)	boiling	evaporation	freezing
(2)	boiling	condensation	evaporation
(3)	evaporation	condensation	freezing
(4)	evaporation	freezing	condensation

24. The diagram shows the water cycle.

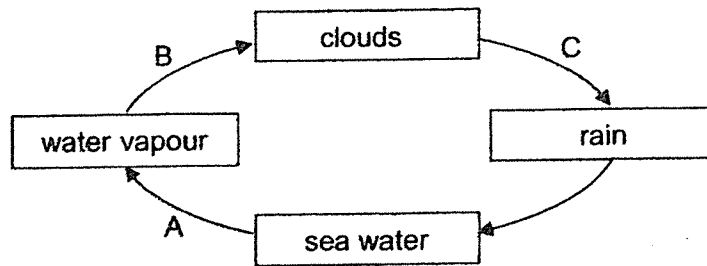

Which of the following is correct?

	Heat is gained at	Heat is lost at
(1)	A	B
(2)	A	C
(3)	B	C
(4)	C	A

25. The diagram shows the human male and female reproductive systems.

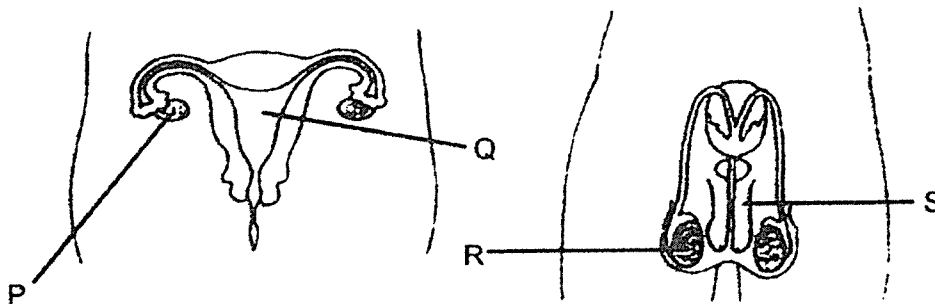

Which two parts, P, Q, R or S, produce reproductive cells?

- (1) P and R
- (2) P and S
- (3) Q and R
- (4) Q and S

26. Peter prepared the set-up as shown.

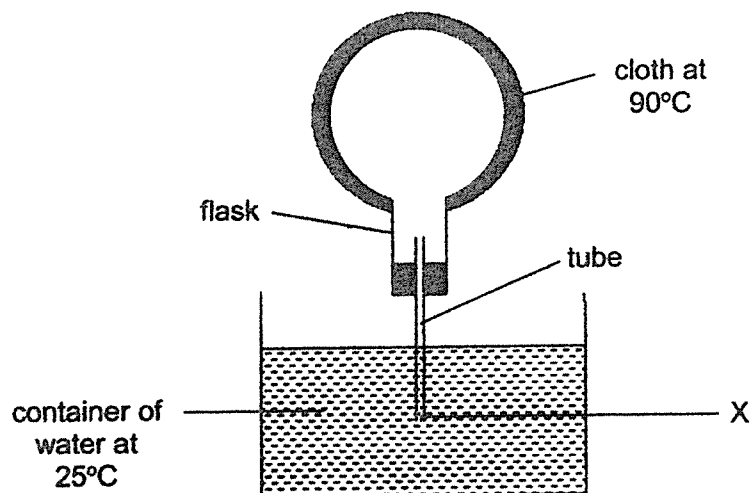

Five minutes after Peter placed the cloth on the flask, he observed a change.

Which of the following observation did he make and what was the reason for his observation?

	Observation	Reason
(1)	Water rose up the tube.	Air in the flask lost heat to the cloth.
(2)	Water rose up the tube.	Air in the flask contracted.
(3)	Bubbles escaped at part X.	Air in the flask has more mass.
(4)	Bubbles escaped at part X.	Air in the flask takes up more space.

27. The set-up shows light shining on three objects, A, B and C, made of cardboard, placed at different distances from a lighted torch.

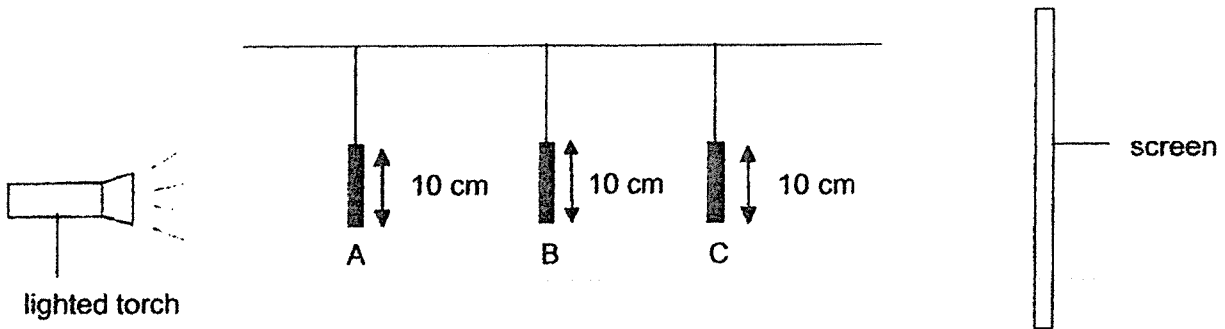

The diagram below shows the shadow formed on the screen.

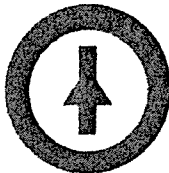

What are objects A, B and C?

	A	B	C
(1)			
(2)			
(3)			
(4)			

28. Jeremy was walking from J to L, passing by a lamp.

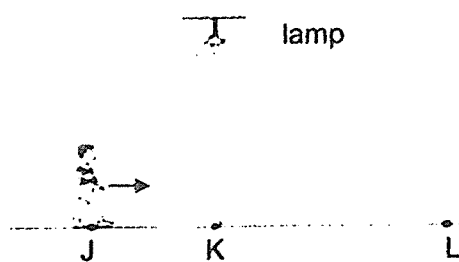

Which graph shows how the length of Jeremy's shadow changes as he walks from J to L?

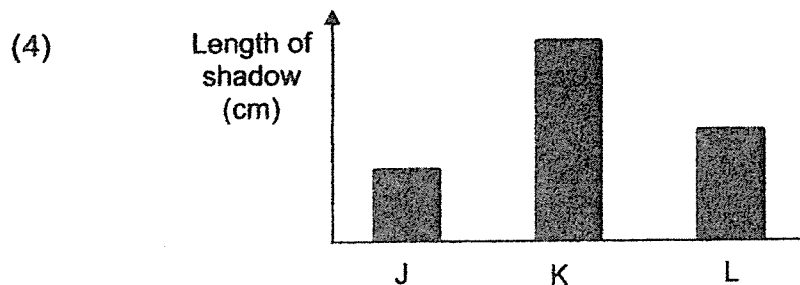
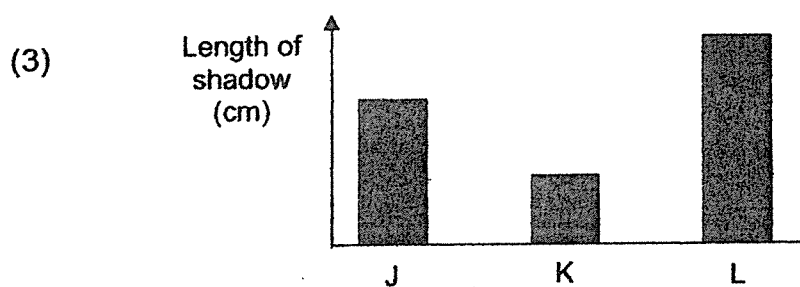
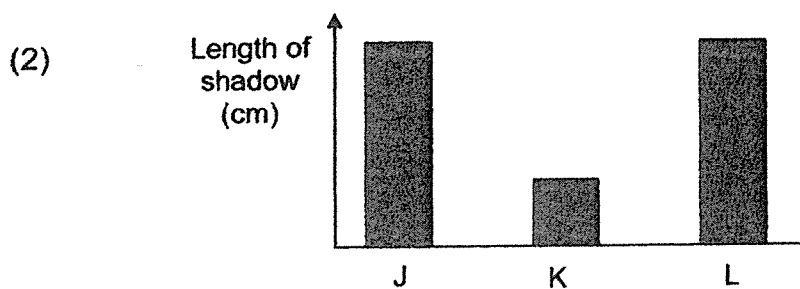
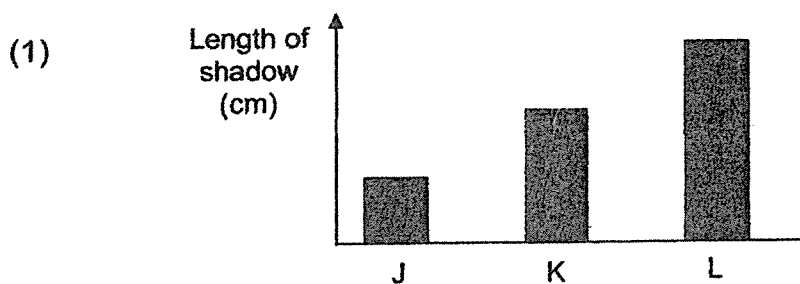

End of Booklet A

Anglo-Chinese School (Junior)



SEMESTRAL ASSESSMENT (2021)

PRIMARY 5

SCIENCE

BOOKLET B

Monday

1 November 2021

1 hr 45 min

Name: _____ () Class: 5.() Parent's Signature: _____

INSTRUCTIONS TO PUPILS

- 1 Do not turn over the pages until you are told to do so.
- 2 Follow all instructions carefully.
- 3 There are 13 questions in this booklet.
- 4 Answer ALL questions.
- 5 The marks are given in the brackets [] at the end of each question or part question.

Booklet	Possible Marks	Marks Obtained
A	56	
B	44	
Total	100	

This question paper consists of 16 printed pages (inclusive of cover page).

For questions 29 to 41, write your answers in this booklet.
The number of marks available is shown in brackets [] at the end of each question or part question. [44 marks]

29 The parts of a flower are labelled A to D as shown.

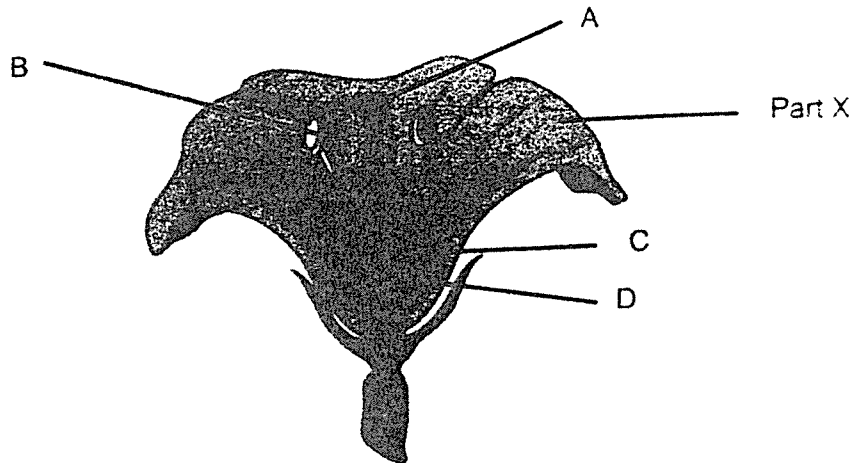

(a) Which part of the flower, A, B, C or D, will develop into the fruit once the flower has been pollinated and fertilised? [1]

(b) Part X is important to insect-pollinated flowers. State two characteristics of part X that help the flower to be pollinated by insects. [1]

(c) Wind-pollinated flowers usually produce pollen grains in large numbers. Explain why this is so. [1]

(Go on to the next page)

SCORE	/
-------	---

- 30 Timothy carried out an experiment in a dark room with the set-up shown. He arranged three sheets made of different materials, W, X and Y, in a straight line.

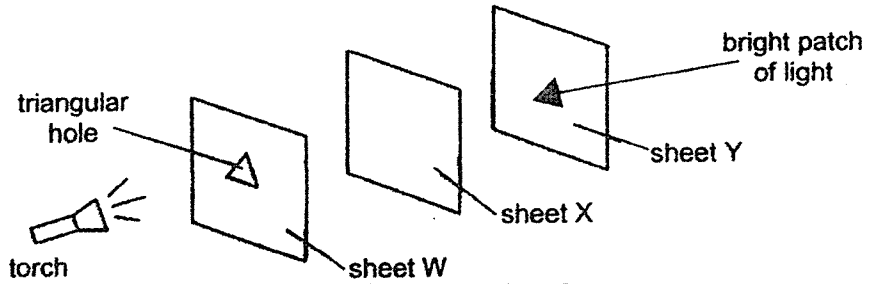

When the torch was switched on, Timothy observed that a bright patch of light in the shape of a triangle was seen on sheet Y only.

- (a) State the property of light shown in this experiment. [1]

- (b) State the property of sheet W and sheet X. [1]

Sheet W: _____

Sheet X: _____

- (c) What will happen to the size of the bright patch of light on sheet Y if he moves sheet W closer to the torch? Explain your answer. [1]

Timothy then moved sheet Y in front of sheet X.

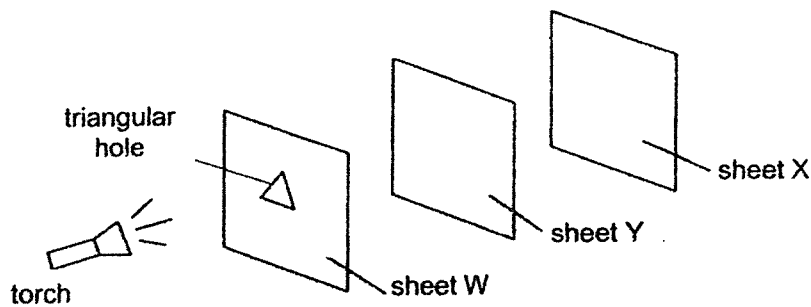

- (d) Would Timothy observe a bright patch of light in the shape of a triangle on sheet X when the torch is switched on? Give a reason for your answer. [1]

(Go on to the next page)

SCORE	
	4

31 Mei Li wanted to find out how the colour of containers affect the rate at which water in the containers gained heat.

She prepared two set-ups as shown using containers of different colours and similar thermometers and placed them in the garden under the Sun for two hours.

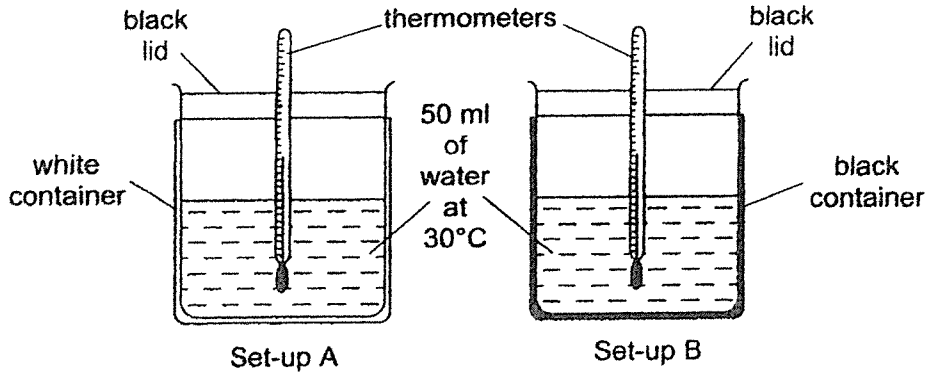

Her results are shown in the graph.

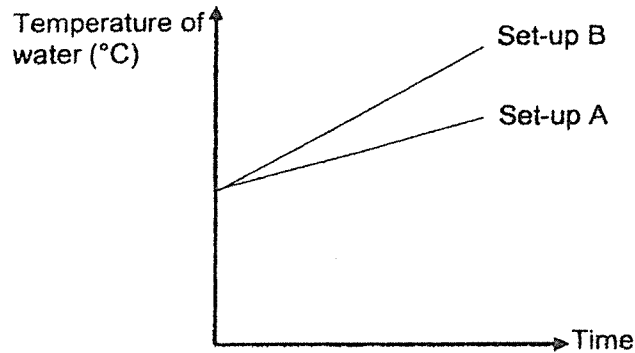

(a) Based on the results, what can Mei Li conclude about her experiment? [1]

(b) What two other variables must she keep the same to ensure a fair test? [1]

Go on to the next page)

SCORE	2
-------	---

- (c) Based on the results, which colour, black or white, is more suitable to be used to paint park benches for people who visit the park in the afternoon? Explain why. [1]

- (d) Which material, steel or wood, would be more suitable to make the park benches for the people who visit the park in the afternoon? Give a reason for your answer. [1]

- 32 Shirley investigated how different amount of light affects the rate of photosynthesis of different water plants.

She set up the experiment using water plant X and carried out the experiment in a dark room as shown. She counted the number of bubbles produced by the plant every 10 minutes and repeated the experiment using water plant Y.

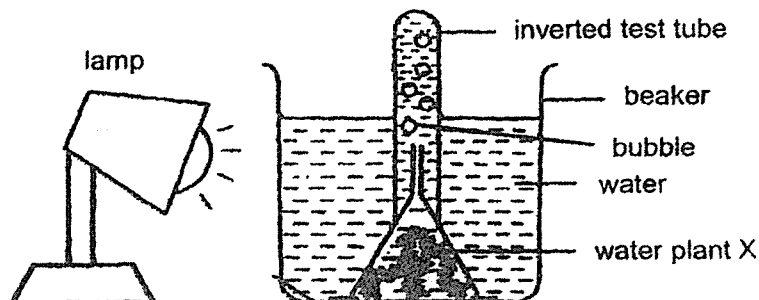

She recorded the results in the graph.

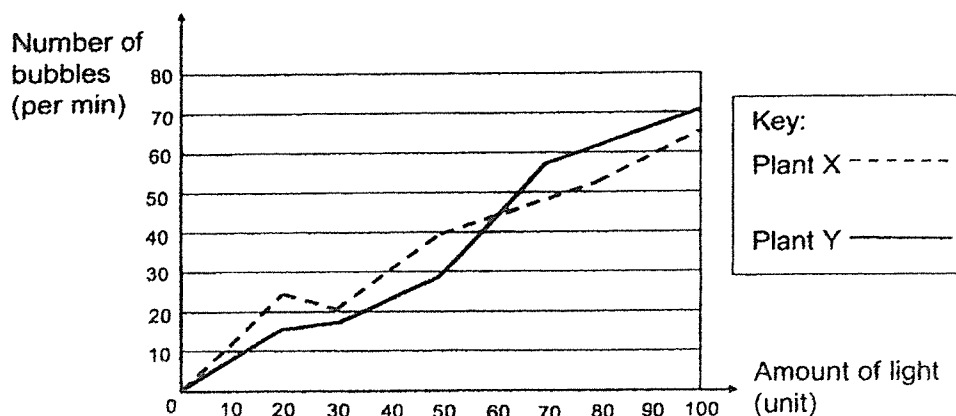

- (a) What is the relationship between the amount of light and the rate of photosynthesis for plant Y? [1]

- (b) State the gas the bubbles contain. [1]

- (c) Based on the results above, which plant, X or Y, is more suited to grow in a pond with 50 units of light or less? Explain your answer. [1]

(Go on to the next page)

SCORE	3
-------	---

33 The table shows four matters.

Steam	Mist
Water vapour	Rice grains

(a) Classify the four matters in the classification chart according to their states. [2]

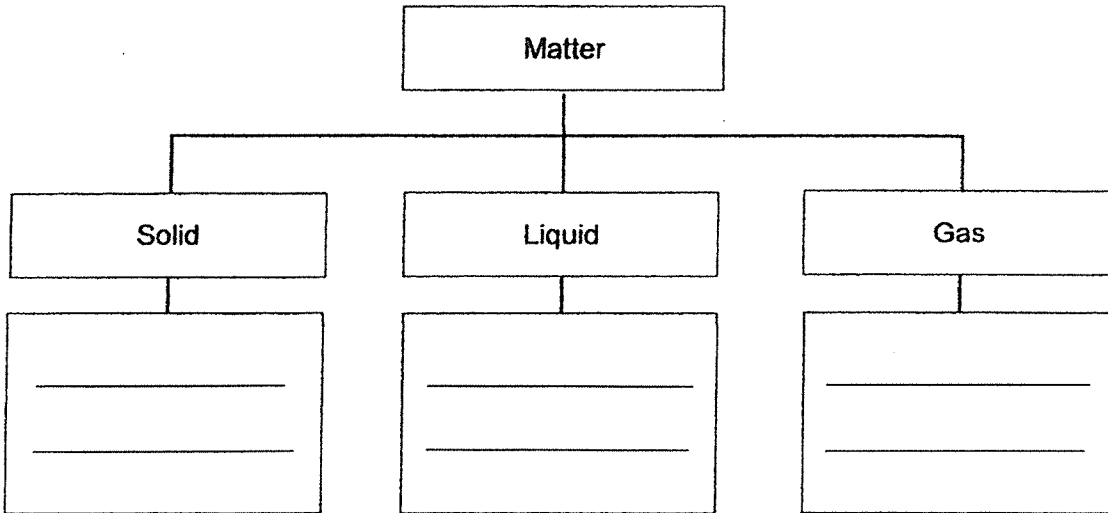

(b) The four matters may be reclassified differently based on their properties. Complete the sub-headings in the classification chart below. [1]

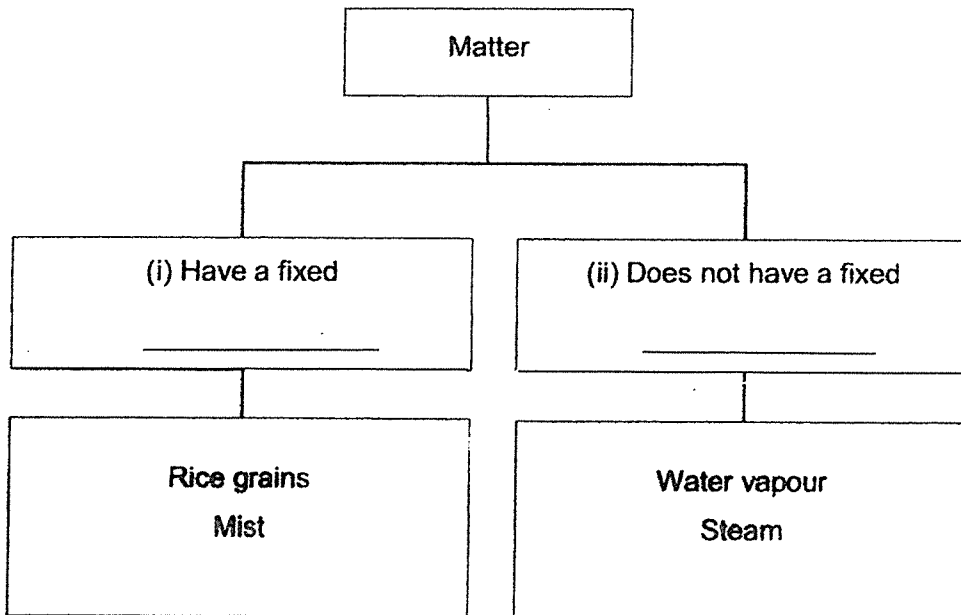

(Go on to the next page)

SCORE	3
-------	---

34 Study the diagram.

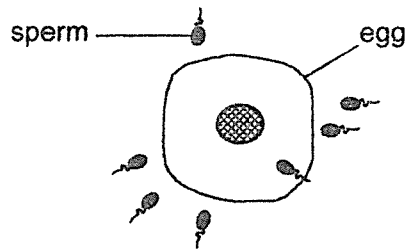

(a) State the process that is taking place.

The diagram shows an unborn human baby.

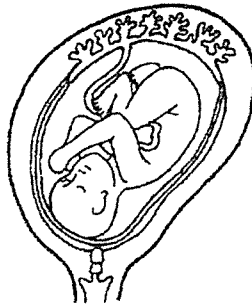

(b) For each statement, tick (✓) if it is 'True' or 'False'.

		True	False
(i)	The baby developed from a fertilised egg.		
(ii)	The baby grows in the mother's stomach.		
(iii)	The unborn baby does not need any food at this stage.		
(iv)	Cells of the baby contain genetic information from both the mother and the father.		

(Go on to the next page)

SCORE	3
-------	---

35 The diagram shows the water cycle.

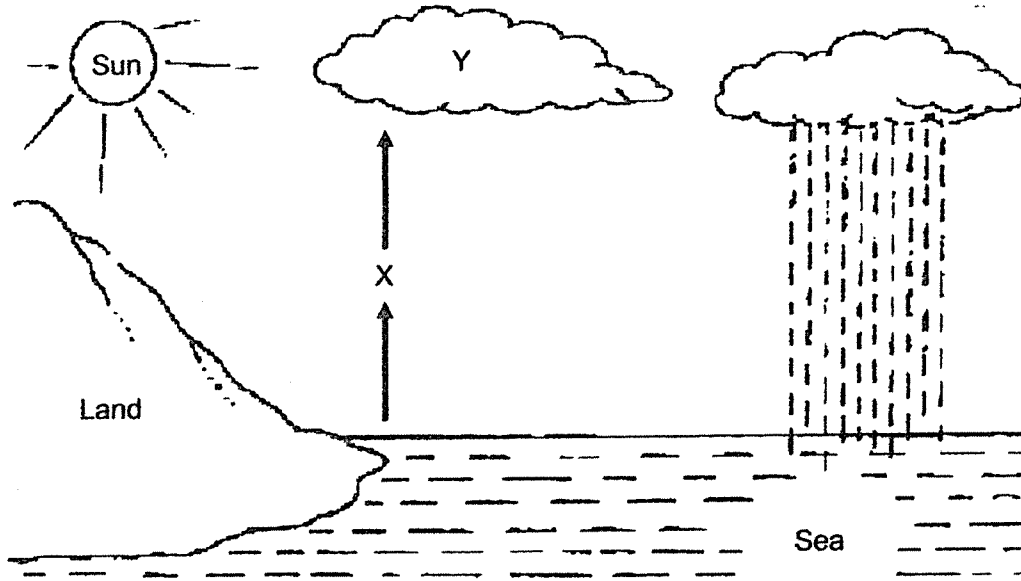

(a) What are the **states** of water at X and Y? [1]

X: _____ Y: _____

(b) Describe how Y is formed in the water cycle shown. [2]

(Go on to the next page)

SCORE	3
-------	---

- 36 Jack heated salt water using set-up X until a liquid was collected in the test-tube as shown. The condenser is used for condensing water vapour.

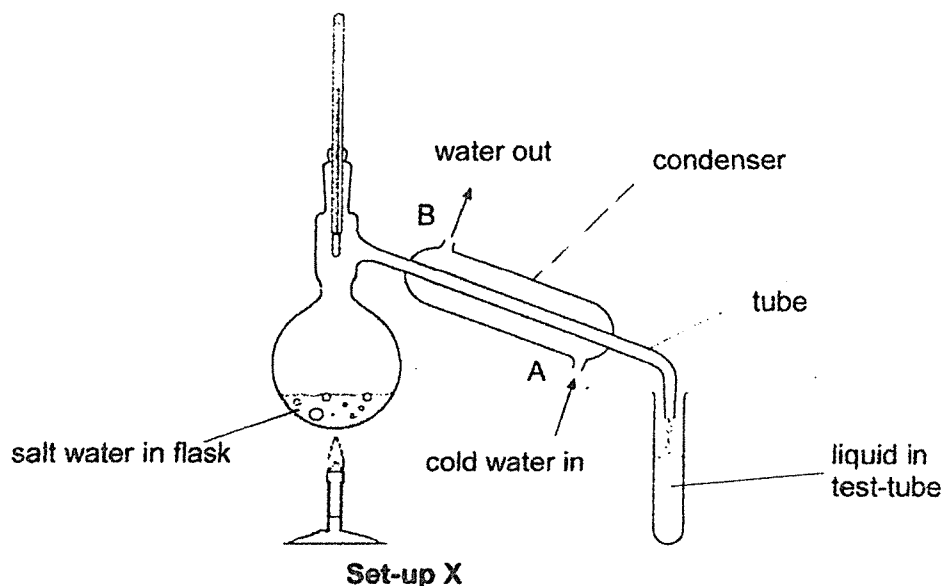

- (a) Which process(es) occurred in set-up X? Tick (✓) the correct box(es). [1]

Process	Tick (✓)
Condensation	
Evaporation	
Boiling	
Melting	

- (b) Name the solid left in the flask at the end of the experiment and the liquid that is collected in the test-tube. [1]

Solid: _____

Liquid: _____

- (c) Describe what happens to water vapour that enters the glass tube. [1]

(Go on to the next page)

SCORE	3
-------	---

- (d) Water at 15°C enters the condenser at A and water at a higher temperature than 15°C leaves the condenser at B. Give a reason why the temperature of the water increased. [1]

Jill repeated the experiment with the same volume of salt water using set-up Y as shown.

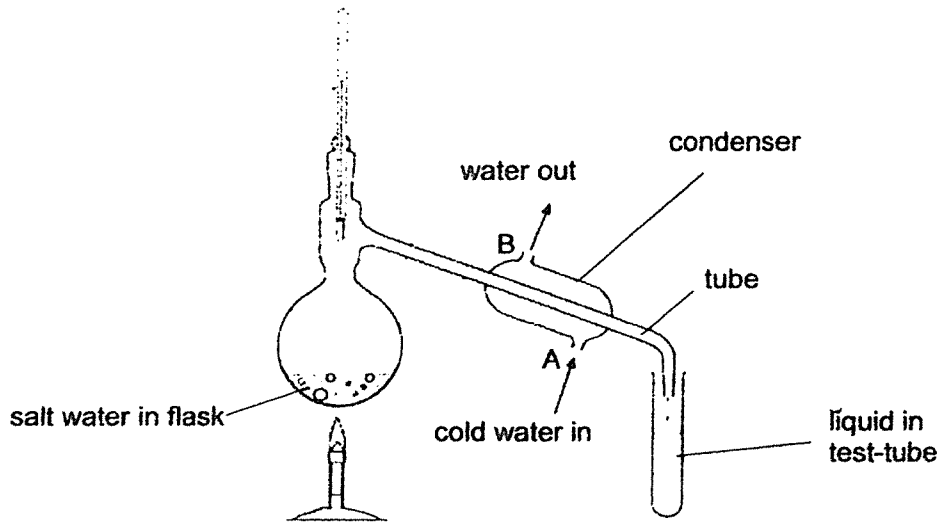

Set-up Y

- (e) The length of the condenser in set-up X is longer than that in set-up Y. How does this affect the volumes of liquid collected in both set-ups? [1]

(Go on to the next page)

SCORE	2
-------	---

- 37 Jeffery wanted to investigate how the number of new working batteries affect the number of paper clips attracted by an electromagnet using the set-up.

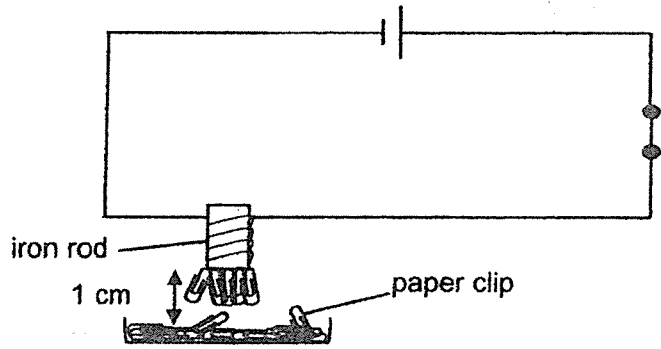

He placed the iron rod 1 cm from some paper clips and counted the number of paper clips that were attracted to it.

His results are shown in the graph.

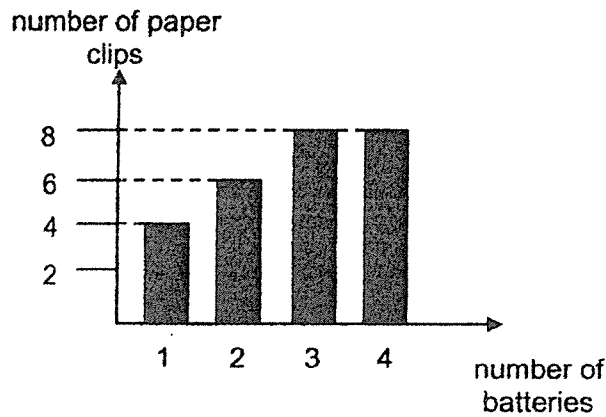

- (a) Explain why the paper clips were attracted by the iron rod when the switch is closed. [1]

- (b) Suggest a reason why the number of paper clips attracted to the electromagnet remained the same when the number of batteries was three and four. [1]

- (c) Explain why placing the tray of paper clips 1 cm away from the iron rod throughout the experiment ensures that it is a fair test. [1]

(Go on to the next page)

SCORE	3
-------	---

38 Gordan conducted an experiment to find out how the contact surface area of food exposed to digestive juices affects the speed at which food is digested.

Gordan used two identical beakers, 200 g of food, and 1000 ml of digestive juice to prepare set-ups 1 and 2.

(a) In the space given, use a ruler to draw and label set-up 2 to test the aim of his experiment. The beakers have been drawn for you. [1]

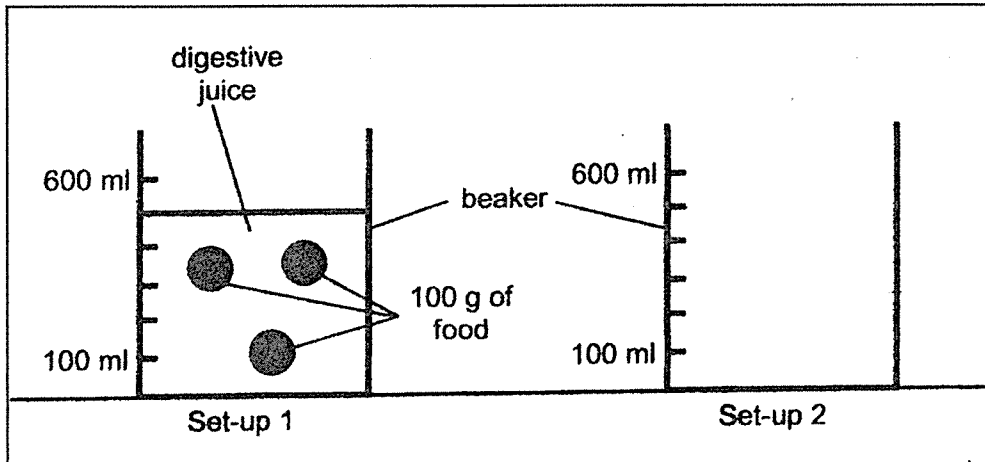

(b) In which set-up, 1 or 2, will the mass of food be smaller after two hours? Explain your answer. [2]

(Go on to the next page)

SCORE	/
	3

- 39 Plant X is commonly found in deserts where temperatures are high in the day and low at night. It is able to store air in its leaves.

Quincy observed the cells of a leaf of plant X during the night and day as shown.

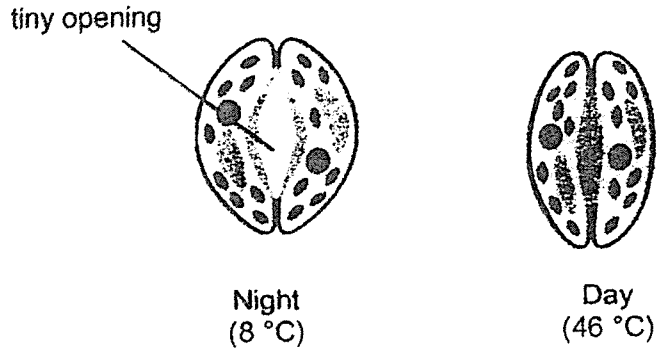

- (a) State the function of the tiny openings on leaves. [1]

- (b) State a reason why the tiny openings of plant X are closed during the day. [1]

- (c) Based on plant X's ability to store air in its leaves, explain how it is able to photosynthesise in the desert in the day although its tiny openings are closed. [1]

(Go on to the next page)

SCORE	
	3

- 40 The tables show the average resting heart rate of males who exercise daily.

Males who exercise daily	
Age	Average resting heart rate per minute
18-25	52
26-35	54
36-45	58
46-55	59

- (a) State the relationship between age and average resting heart rate. [1]

The picture shows a male exercising.



- (b) Explain why our heart rate increases when we exercise. [2]

(Go on to the next page)

SCORE	3
-------	---

41 Vincent made a flash lamp for his Science project. He set up the electric circuit using two bulbs and two batteries in working condition as shown.

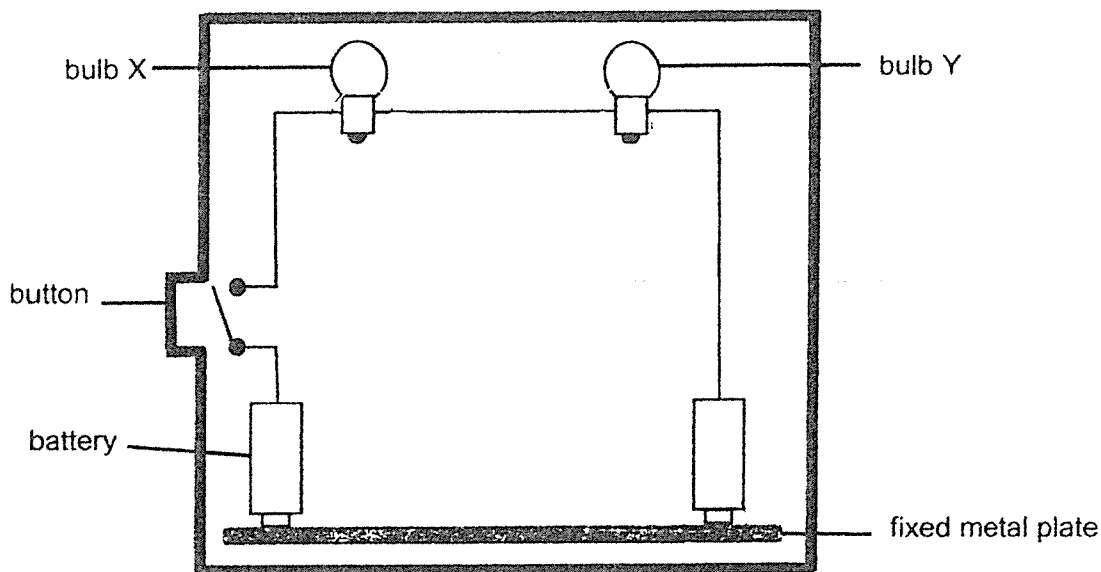

However, when Vincent pressed the button, bulbs X and Y did not light up.

(a) Draw a circuit below to correct Vincent's mistake(s). [2]

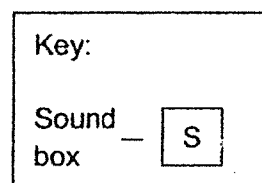
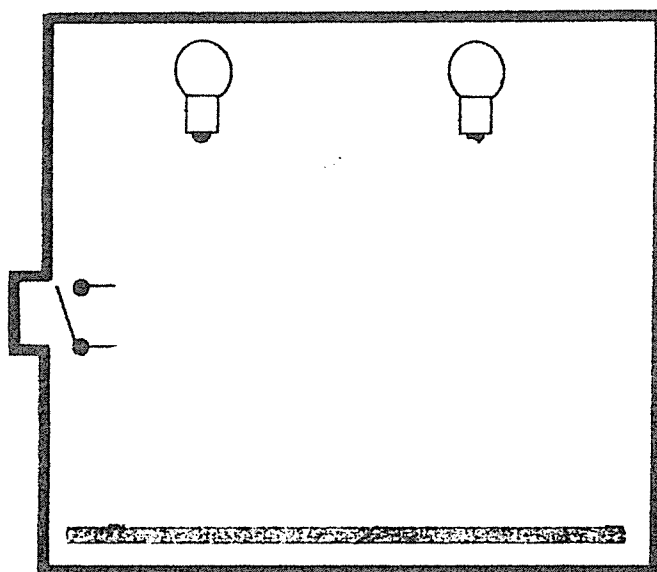

Vincent decided to add a sound box to his flash lamp. Only when the switch is closed, the sound box will ring without dimming the bulbs.

(b) Draw on your circuit in (a) how you would connect the sound box. [1]

(c) Draw a 'X' in the circuit in (a) to show where another switch should be placed such that it controls only the sound box. [1]

End of Paper

SCORE	4
-------	---

ANSWER KEY

YEAR : 2021
LEVEL : PRIMARY 5
SCHOOL : ANGLO-CHINESE SCHOOL (JUNIOR)
SUBJECT : SCIENCE
TERM : SA2

BOOKLET A

Q1	4	Q2	4	Q3	1	Q4	2	Q5	4
Q6	3	Q7	3	Q8	3	Q9	2	Q10	4
Q11	3	Q12	1	Q13	2	Q14	4	Q15	1
Q16	4	Q17	3	Q18	1	Q19	4	Q20	1
Q21	3	Q22	3	Q23	3	Q24	1	Q25	1
Q26	4	Q27	4	Q28	3				

BOOKLET B

Q29	(a) Part C (b) Brightly-coloured and produces a sweet scent (c) This increases the chances of wind transferring pollen grains from anther to stigma. Hence, increasing the chances of successful pollination of the flower occurring and fertilisation occurring.
Q30	(a) Light travels in a straight line (b) Sheet W: Opaque Sheet X: Transparent (c) It increases in size. When sheet Y is moved closer to the torch, more light travelling in a straight line from the torch pass through the hole, increasing the light's size. (d) No. Sheet X is transparent and hence, although sheet W and Y are opaque, all light passes through sheet X, hence the bright patch of light is not found on sheet X.
Q31	(a) Black colour is a better conductor of heat than white colour (b) Thickness of container and size of container (c) White colour. As the white colour is a poorer conductor of heat than black colour, it gains heat from the hotter afternoon surrounding air slower than black coloured benches. So it is cooler than black-coloured benches, hence more comfortable for people to sit on. (d) Wood. Wood is a poorer conductor of heat than steel so it gains heat from the hotter afternoon surrounding air slower and will be cooler than

	steel benches, hence more comfortable for people to sit on.																						
Q32	<p>(a) As the amount of light increases, the rate of photosynthesis of plant Y increases.</p> <p>(b) Oxygen</p> <p>(c) Plant X. Plant X produced more bubbles than plant Y when 50 units of light or less was received/trapped by plant Y, showing that plant X had a higher rate of photosynthesis than plant Y when there is 50 units of light or less. Hence, it makes more food than plant Y when given 50 units of light.</p>																						
Q33	<p>(a) Solid: Rice grains Liquid: Mist Gas: Steam and water vapour</p> <p>(b) (i) Volume (ii) Volume</p>																						
Q34	<p>(a) Fertilisation</p> <p>(b)</p> <table border="1"> <thead> <tr> <th></th> <th></th> <th>True</th> <th>False</th> </tr> </thead> <tbody> <tr> <td>(i)</td> <td>The baby developed from the fertilised egg.</td> <td>✓</td> <td></td> </tr> <tr> <td>(ii)</td> <td>The baby grows in the mother's stomach.</td> <td></td> <td>✓</td> </tr> <tr> <td>(iii)</td> <td>The unborn baby does not need any food at this stage.</td> <td></td> <td>✓</td> </tr> <tr> <td>(iv)</td> <td>Cells of the baby contain genetic information from both the mother and the father.</td> <td>✓</td> <td></td> </tr> </tbody> </table>					True	False	(i)	The baby developed from the fertilised egg.	✓		(ii)	The baby grows in the mother's stomach.		✓	(iii)	The unborn baby does not need any food at this stage.		✓	(iv)	Cells of the baby contain genetic information from both the mother and the father.	✓	
		True	False																				
(i)	The baby developed from the fertilised egg.	✓																					
(ii)	The baby grows in the mother's stomach.		✓																				
(iii)	The unborn baby does not need any food at this stage.		✓																				
(iv)	Cells of the baby contain genetic information from both the mother and the father.	✓																					
Q35	<p>(a) X: Gas Y: Liquid</p> <p>(b) Water in the sea gained heat from the sun and evaporated as water vapour. When warmer water vapour came into contact with the cooler sky, it lost heat, condensing into water droplets, forming Y, cloud</p>																						
Q36	<p>(a)</p> <table border="1"> <thead> <tr> <th>Process</th> <th>tick</th> </tr> </thead> <tbody> <tr> <td>condensation</td> <td>✓</td> </tr> <tr> <td>evaporation</td> <td>✓</td> </tr> <tr> <td>boiling</td> <td>✓</td> </tr> <tr> <td>melting</td> <td></td> </tr> </tbody> </table> <p>(b) solid: Salt Liquid: Pure fresh water</p> <p>(c) Warmer water vapour entered the glass tube, came into contact with the cooler inner surface of condenser, lost heat, condensing into water droplets that dripped into the test tube.</p> <p>(d) The cold water at 15°C gained heat from the warmer water vapour in the condenser as the warmer water vapour lost heat to the condenser. As heat was gained, the temperature of water increased.</p> <p>(e) A greater volume of liquid is collected in the test tube in set-up X than</p>			Process	tick	condensation	✓	evaporation	✓	boiling	✓	melting											
Process	tick																						
condensation	✓																						
evaporation	✓																						
boiling	✓																						
melting																							

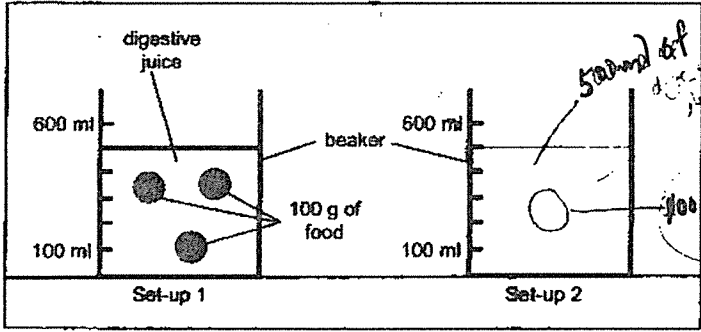
	set-up Y. As the warmer water vapour lost more heat in set-up X than Y.
Q37	<p>(a) When the switch was closed, electric current flowed through the closed circuit, magnetising the iron rod to become an electromagnet and attracts the paper clip.</p> <p>(b) The electromagnet had reached its highest rate of attracting paper clips and reached its greatest magnetic strength. Hence, it was not able to pick up more.</p> <p>(c) This ensure that only the number of new working batteries affects the number of paper clips attracted by the electromagnet and not other factors.</p>
Q38	<p>(a)</p>  <p>(b) set-up 1. The food in set-up 1 had a greater contact surface area exposed to digestive juices broke down food in set-up 1 faster than set-up 2 , hence the food in set-up 1 is digested faster, hence the mass of food is smaller in set-up 1 than in set-up 2.</p>
Q39	<p>(a) It allows gaseous exchange to take place between the leaves and surrounding air.</p> <p>(b) To reduce water loss in the plants leaves.</p> <p>(c) At night, it opens its stomata to allow carbon dioxide to enter the stomata and be stored. In the presence of light in the day, the leaf traps light, photosynthesis and produces food and oxygen.</p>
Q40	<p>(a) As the age of males who exercise daily increases, their average resting heart rate increases.</p> <p>(b) When we exercise, our heart pumps faster to pump necessary transport more oxygen and digested food in the blood to all parts of the body to undergo a greater rate of respiration and release more energy.</p>
Q41	